

1T6659DA | FORTYEIGHT Label 4

Low voltage adjustable LED professional projector

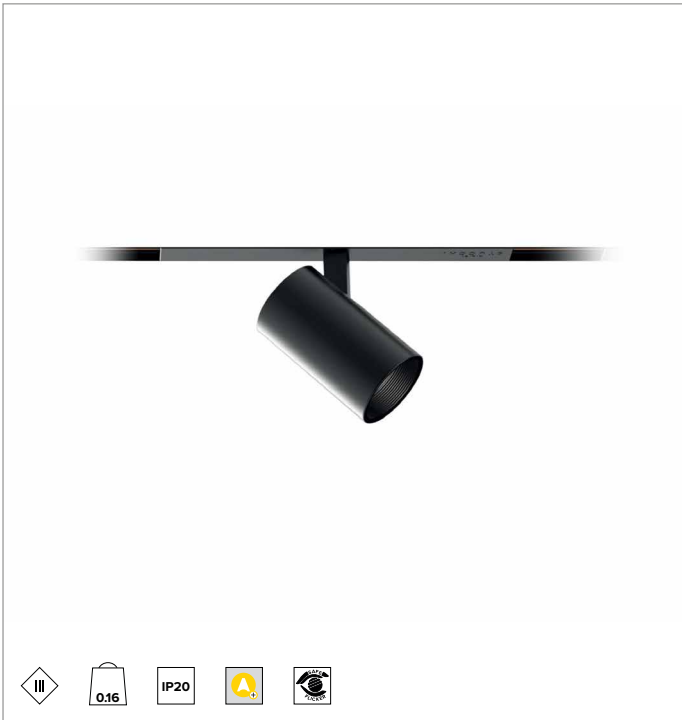

	4000K	H(m)	D(m)	Emax(lx)		
	Ra90		18°			
	Fixture Power	9W	1	0.31	4879	
	Source Flux	1137lm	2	0.62	1220	
	Fixture Flux	720lm	3	0.93	542	
	Efficacy	76lm/W	4	1.24	305	
TS1952	Imax=4291cd/klm	Imax	4879cd	5	1.55	195

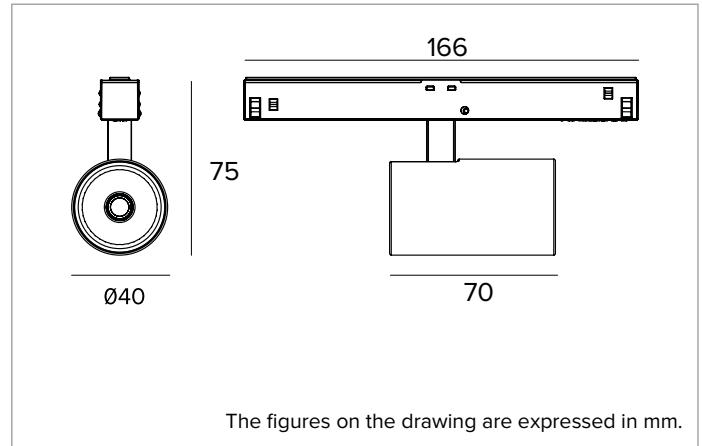

SOURCE

High efficiency Chip on Board LED Ra90. 3500K on request.

Energy efficiency class: F

Nominal power: 8,7W

Nominal flux: 1137lm

Colour rendering index: 90

Rf: 90

Rg: 98

CCT nominal: 4000K

SDCM: 1.5

Lifetime (L80/B10): >50000h tq +25°C

ILLUMINOTECHNICAL CHARACTERISTICS

SP - metallised polycarbonate precision optics, a holographic diffusion filter and a black silicone cut off ring.

Optic: REFLECTOR

Beam angles: SP

Optical efficiency: 63%

Fixture flux: 720lm

Luminous efficacy: 76lm/W

Photobiological safety: Compliant with RG1 low risk group

MECHANICAL CHARACTERISTICS

Painted die-cast aluminium body. The optical unit can be adjusted from 0° a 90° on the vertical plane and 360° on the horizontal plane with friction locking system.

Colour and finish: Plaster white

Dimensions: D=40mm

Weight: 0.16Kg

Version: DALI

Degree of protection: IP20

ELECTRICAL CHARACTERISTICS

DALI version with track power supply. Casambi control system available using a dedicated accessory.

Fixture Power: 10W

Power supply: 48Vdc

Insulation Class: CLASS 3

Class F: YES

SAFE FLICKER: PstLM=<1 and SVM=<0.4 (IEC TR 61547-1 and IEC TR 63158), to ensure a more comfortable and safe light

Ambient temperature: 0°C / +25°C

INSTALLATION

Quick coupling system for mounting the product on the track.

NOTES

Not polarized fixture. The arm is and the adapter are supplied in the same colour as the body of the projector. 110-277Vac version available on request. Commissioning of the control system via free APP; the intervention of a specialist technician can be quoted on request.

WARRANTY

5 years.

WARNING

Luminaire designed for disposal/recycling at end-of-life. Replaceable (LED only) light source by a professional. Replaceable control gear by a professional.

Due to the technological evolution of the electronic components, the data provided may be updated, and as such, confirmation must be requested during the order process.

Luminous flux and power supply have +/-10% tolerances with respect to the indicated value. tq +25°C (CIE 121).

We reserve the right to make technical changes.

Targetti Sankey S.r.l.
Via Pratese, 164
50145 Firenze - Italy
Tel: +39 055 37911
targetti.com
targetti@targetti.com

CCIAA Firenze
Share Capital:
€ 500.000,00
VAT N. (IT):
01537660480
R.E.A: FI-275656

TARGETTI

1T6659DA | FORTYEIGHT Label 4
Low voltage adjustable LED professional projector

Accessories

Filter



Ø mm	Code
34	1T6931

PMMA holographic filter with blade effect to ovalize the light beam; more evident when combined with spot and flood optics.

Grid



Ø mm	Code
34	1T6930

Anti-glare louver.
 Black painted metal honeycomb structure.
 Complete with holographic diffusion filter.

*Due to the technological evolution of the electronic components, the data provided may be updated, and as such, confirmation must be requested during the order process.
 Luminous flux and power supply have +/-10% tolerances with respect to the indicated value. tq +25°C (CIE 121).*

We reserve the right to make technical changes.

Targetti Sankey S.r.l.
 Via Pratese, 164
 50145 Firenze - Italy
 Tel: +39 055 37911
 targetti.com
 targetti@targetti.com

CCIAA Firenze
 Share Capital:
 € 500.000,00
 VAT N. (IT):
 01537660480
 R.E.A: FI-275656

